

Panasonic ®

Cordless MULTI Drill & Driver

Operating Instructions

Model No. : EY6535



IMPORTANT

This manual contains safety information. Read manual completely before first using this product and save this manual for future use.

SAVE THESE INSTRUCTIONS

GENERAL SAFETY RULES- FOR ALL BATTERY OPERATED TOOLS

WARNING!

Read and understand all instructions
- Failure to follow all instructions listed below, may result in electric shock, fire and/or serious personal injury

SAVE THESE INSTRUCTIONS

Work Area

- 1) **Keep your work area clean and well lit**
Cluttered benches and dark areas invite accidents
- 2) **Do not operate power tools in explosive atmospheres, such as in the presence of flammable liquids, gases, or dust**
Power tools create sparks which may ignite the dust or fumes
- 3) **Keep bystanders, children, and visitors away while operating a power tool**
Distractions can cause you to lose control. Make sure that no one is beneath, or on the other side of the area when you are working

Electrical Safety

- 4) **A battery operated tool with integral batteries or a separate battery pack must be recharged only with the specified charger for the battery**
A charger that may be suitable for one type of battery may create a risk of fire when used with another battery
- 5) **Use battery operated tool only with specifically designated battery pack**
Use of any other batteries may create a risk of fire

Personal Safety

- 6) **Stay alert, watch what you are doing, and use common sense when operating a power tool. Do not use tool**

while tired or under the influence of drugs, alcohol, or medication
A moment of inattention while operating power tools may result in serious personal injury

- 7) **Dress properly. Do not wear loose clothing or jewelry. Contain long hair. Keep your hair, clothing, and gloves away from moving parts**
Loose clothes, jewelry, or long hair can be caught in moving parts
- 8) **Avoid accidental starting. Be sure switch is in the locked or off position before inserting battery pack**
Carrying tools with your finger on the switch or inserting the battery pack into a tool with the switch on invites accidents
- 9) **Remove adjusting keys or wrenches before turning the tool on**
A wrench or a key that is left attached to a rotating part of the tool may result in personal injury
- 10) **Do not overreach. Keep proper footing and balance at all times**
Proper footing and balance enable better control of the tool in unexpected situations
- 11) **Use safety equipment. Always wear eye protection**
Dust mask, non-skid safety shoes, hard hat, or hearing protection must be used for appropriate conditions

Tool use and care

- 12) **Use clamps or other practical way to secure and support the workpiece to a stable platform**
Holding the work by hand or against your body is unstable and may lead to loss of control
- 13) **Do not force tool. Use the correct tool for your application**
The correct tool will do the job better and safer at the rate for which it is designed
- 14) **Do not use tool if switch does not turn it on or off**

A tool that cannot be controlled with the switch is dangerous and must be repaired

- 15) **Disconnect battery pack from tool or place the switch in the locked or off position before making any adjustments, changing accessories, or storing the tool**

Such preventive safety measures reduce the risk of starting the tool accidentally

- 16) **Store idle tools out of reach of children and other untrained persons**

Tools are dangerous in the hands of untrained users

- 17) **When battery pack is not in use, keep it away from other metal objects like paper clips, coins, keys, nails, screws, or other small metal objects that can make a connection from one terminal to another**

Shorting the battery terminals together may cause sparks, burns or a fire

- 18) **Maintain tools with care Keep cutting tools sharp and clean**

Properly maintained tools with sharp cutting edge are less likely to bind and are easier to control

- 19) **Check for misalignment or binding of moving parts, breakage of parts, and any other condition that may affect the tool's operations If damaged, have the tool serviced before using**

Many accidents are caused by poorly maintained tools

- 20) **Use only accessories that are recommended by the manufacturer for your model**

Accessories that may be suitable for one tool may create a risk of injury when used on another tool

Service

- 21) **Tool service must be performed only by qualified repair personnel**

Service or maintenance performed by unqualified personnel may result in a risk of injury



- 22) **When servicing a tool, use only identical replacement parts Follow instructions in the Maintenance section of this manual**

Use of unauthorized parts or failure to follow Maintenance Instructions may create a risk of shock or injury

SPECIFIC SAFETY RULES

- 1) **Hold tool by insulated gripping surfaces when performing an operation where the cutting tool may contact hidden wiring**

Contact with a "live" wire will make exposed metal parts of the tool "live" and shock the operator

Symbol	Meaning
V	Volts
	Direct Current
no	no load speed
/min	revolutions or reciprocation per minutes
	Rotation only

WARNING!

Some dust created by power sanding, sawing, grinding, drilling, and other construction activities contains chemicals known to the State of California to cause cancer, birth defects or other reproductive harm Some examples of these chemicals are

- Lead from lead-based paints
- Crystalline silica from bricks and cement and other masonry products
- Arsenic and chromium from chemically-treated lumber

To reduce your exposure to these chemicals

work in a well ventilated area, and work with approved safety equipment, such as dust masks that are specially designed to filter our microscopic particles

FOR BATTERY CHARGER & BATTERY PACK

1) **SAVE THESE INSTRUCTIONS**

-This manual contains important safety and operating instructions for battery charger EY0230

- 2) Before using battery charger, read all instructions and cautionary markings on (1) battery charger, (2) battery pack

- 3) **CAUTION** -To reduce the risk of injury, charge only Battery Pack as shown below

EY9103, EY9101, EY9001, EY9006, EY9180, EY9080, EY9182, EY9086, EY9065, EY9066, EY9106, EY9107, EY9136, EY9230, EY9200, EY9108, EY9168

Other types of batteries may burst causing personal injury and damage

- 4) Do not expose charger to rain or snow
- 5) To reduce risk of damaging the electric plug and cord, pull by plug rather than cord when disconnecting charger
- 6) Make sure cord is located so that it will not be stepped on, tripped over, or otherwise subjected to damage or stress
- 7) An extension cord should not be used unless absolutely necessary

Use of improper extension cord could result in a risk of fire and electric shock. If extension cord must be used, make sure

- a that pins on plug of extension cord are the same number, size and shape as those of plug on charger
- b that extension cord is properly wired and in good electrical condition
- c that wire size is large enough for ampere rating of charger as specified below

RECOMMENDED MINIMUM AWG SIZE OF EXTENSION CORDS FOR BATTERY CHARGERS					
AC Input Rating	Amperes	AWG Size of Cord			
Equal to or greater than	But less than	Length of Cord Feet			
		25	50	100	150
0	2	18	18	18	16

- 8) Do not operate charger with damaged cord or plug—replace them immediately
- 9) Do not operate charger if it has received a sharp blow, been dropped, or otherwise damaged in any way, take it to a qualified serviceman
- 10) Do not disassemble charger, take it to a qualified serviceman when service or repair is required. Incorrect reassembly may result in a risk of electric shock or fire
- 11) To reduce the risk of electric shock, unplug charger from outlet before attempting any maintenance or cleaning
- 12) The charger and battery pack are specifically designed to work together. Do not attempt to charge any other cordless tool or battery pack with this charger
- 13) Do not attempt to charge the battery pack with any other charger
- 14) Do not attempt to disassemble the battery pack housing
- 15) Do not store the tool and battery pack in locations where the temperature may reach or exceed 122°F (50°C) (such as in a metal tool shed, or a car in the summer), which can lead to deterioration of the storage battery
- 16) Do not charge battery pack when the temperature is BELOW 32°F (0°C) or ABOVE 104°F (40°C). This is very important in order to maintain optimal condition of the battery pack
- 17) Do not incinerate the battery pack. It can explode in a fire
- 18) Avoid dangerous environment. Do not use charger in damp or wet locations

- 19) The charger is designed to operate on standard household electrical power only. Do not attempt to use it on any other voltage!
- 20) Do not abuse cord. Never carry charger by cord or yank it to disconnect from outlet. Keep cord away from heat, oil and sharp edges.
- 21) Charge the battery pack in a well ventilated place, do not cover the charger and battery pack with a cloth, etc., while charging.
- 22) Use of an attachment not recommended may result in a risk of fire, electric shock, or injury to persons.
- 23) Do not short the battery pack. A battery short can cause a large current flow, over heating and create the risk of fire or personal injury.
- 24) NOTE: If the supply cord of this appliance is damaged, it must only be replaced by a repair shop authorized by the manufacturer, because special purpose tools are required.
- 25) TO REDUCE THE RISK OF ELECTRIC SHOCK, THIS APPLIANCE HAS A POLARIZED PLUG (ONE BLADE IS WIDER THAN THE OTHER).
This plug will fit in a polarized outlet only one way. If the plug does not fit fully in the outlet, reverse the plug. If it still does not fit, contact a qualified electrician to install the proper outlet. Do not change the plug in any way.



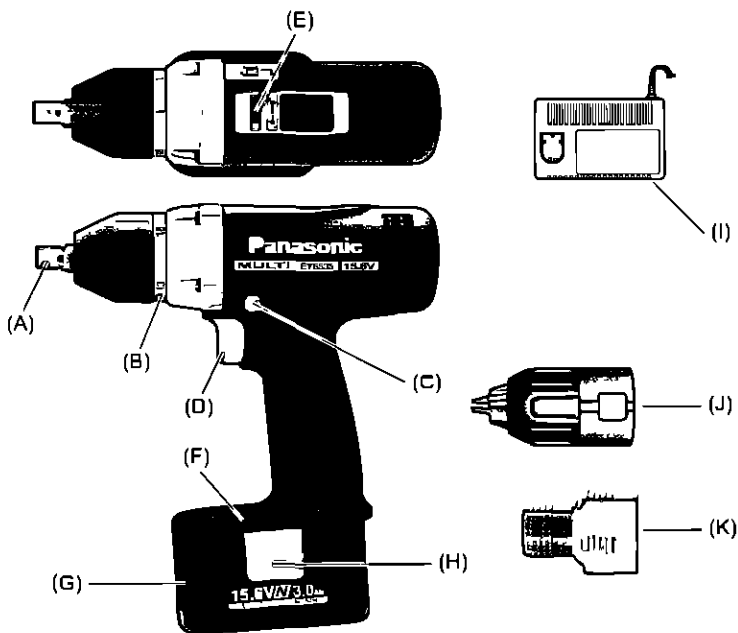





FUNCTIONAL DESCRIPTION



(A)	Square drive (Ball detent)	(B)	Clutch handle
(C)	Reversing lever / Switch lock	(D)	Variable speed control trigger
(E)	Mode Selector switch (Drill driver with clutch function / Impact)	(F)	Bit holder
(G)	Battery pack (EY9230)	(H)	Battery pack release button
(I)	Battery charger (EY0230)	(J)	Keyless drill chuck
(K)	Quick change chuck		

ASSEMBLY

Selecting Mode

Select Mode	Applications & work material		Original Options	Accessories in the market
Drill Driver 	Drilling	Wood Metal	 13mm (1/2") keyless EY9X003E	Wood/metal Hole saw 
		Driving	Wood screw Metal screw	 
Impact 	Fastening		Wood screw Metal screw Tech screw Plastic anchor	 Quick change chuck for 6 35mm (1/4") Hexagonal shank bits (Quick release type) EY9HX110E
		Coach screw (Lag bolt) Bolt nut Concrete anchor		Hexagonal socket 

Select appropriate mode (Drill driver mode or Impact mode) sliding the Mode selector switch

Note When selecting the mode, disconnect battery pack from tool or place Reversing lever in the center position (switch lock)

Do not operate Mode selector switch until the rotation of the spindle comes to a complete stop



Drill driver mode
with clutch function



Impact mode

Attaching or Detaching Original Options and Accessories

Keep the body above freezing point (0°C 32°F) when attach or detach original options and accessories to the square drive on the body. The cushion rubber in the square drive to push up the ball may get hard under freezing point. This requires extra force in detaching and attaching accessories.

Using Keyless drill chuck (EY9X003E)

CAUTION - Use keyless drill chuck ONLY in Drill Driver Mode of EY6535
This chuck is not designed to be used in IMPACT MODE
It can be damaged and its life will be reduced. Moreover, the chuck and its metal parts, such as the push button, front parts, and bit may become very hot. To prevent skin burns, use work gloves and/or allow heated parts to cool down before handling.



- Make sure the work environment is safe. When retracting drill from work material, Keyless drill chuck may detach if subjected to 100kg or more of pull force. Detachment will be sudden. Use care and avoid excessive force when retracting drill from work material.

1 Attaching Keyless drill chuck

Attach the chuck by sliding the female detent on the bottom of the chuck to the square drive on the body.
Make sure the chuck is firmly connected to the body.

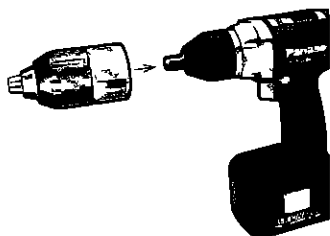

2 Inserting the bit

Insert the bit, and turn the lock collar clockwise (looking from the front) holding the sleeve until jaws close firmly.

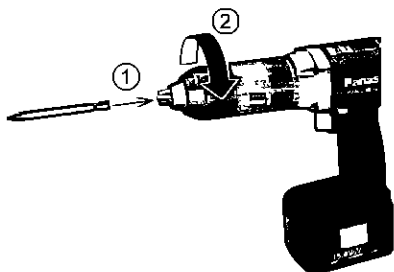

- ## 3 Removing the bit
- Turn the lock collar counterclockwise (looking from the front)
Then remove the bit.

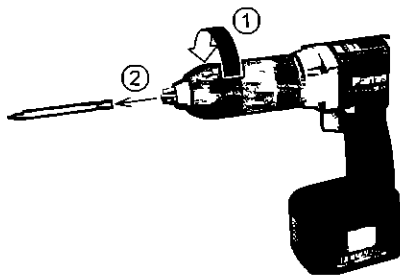

- CAUTION** If the drill bit becomes too tight to remove, hold two lock collars with pipe wrenches and turn them in opposite directions.

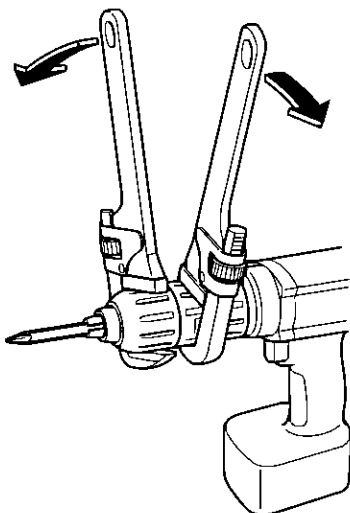

4 Detaching Keyless drill chuck

To detach the chuck, PUSH the button to release the chuck from the square drive.

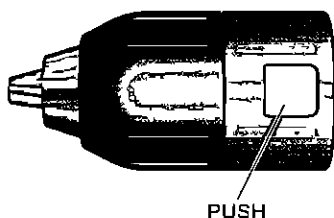

- CAUTION** Drill bit blade is sharp. Make sure to remove the drill bit before you set and detach the keyless drill chuck.

Using Quick change chuck (EY9HX110E)



This Quick change chuck is designed to be used with Panasonic EY6535

- Top collar To insert or to remove bit
 Bottom collar To attach or to detach Quick change chuck

Use 6.35mm (1/4") hexagonal bits

To ensure proper securement of the bit, use only hexagonal bits with 9.25mm (3/8") detent

6.35mm (1/4")



9.25mm (3/8")

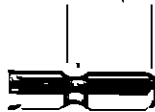

CAUTION Make sure the work environment is safe. When retracting bit from work material, Quick change chuck may detach if subjected to 50kg or more of pull force. Detachment will be sudden. Use care and avoid excessive force when retracting bit from work material.

1 Attaching Quick change chuck

Attach the Quick change chuck by pulling the bottom collar forward and sliding the female detent on the bottom of the chuck to the square drive on the body. Release the bottom collar to make sure the Quick change chuck is firmly connected to the body.

2 Inserting the bit

Pull the top collar of the Quick change chuck forward then insert the bit. Release the bottom collar to make sure the bit is firmly connected to the chuck.

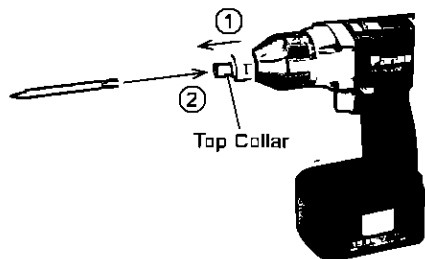

3 Removing the bit

Pull the top collar of the Quick change chuck forward then pull the bit.

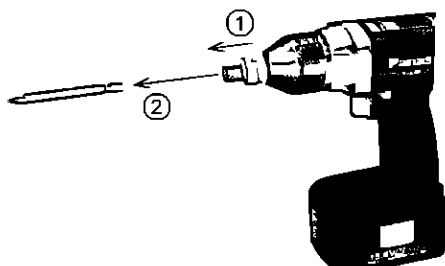

CAUTION Impact mechanism creates heat. Square drive and accessory may become very hot and may cause skin burns. To prevent skin burns, use work gloves and/or allow heated parts to cool down before handling.

4 Detaching Quick change chuck

Pull the bottom collar of the Quick change chuck forward to detach it.

Attaching or removing battery pack

1 To connect the battery pack

Insert the battery pack. It snaps into place to indicate proper connection.

2 To remove the battery pack

Press the two buttons on the sides of the battery pack. Slide the battery pack out of the tool body.

OPERATION

Switch Operation

- The speed increases with the amount of depression of the trigger. When beginning work, depress the trigger slightly to start the rotation slowly.
- A feedback electronic controller is used to give a strong torque even in low speed.
- The brake operates when the trigger is released and the motor stops immediately.

Reversing Lever Operation

(Forward (◻), Switch lock, Reverse (◻))

CAUTION Do not operate reversing lever until rotation of the spindle comes to a complete stop. Shifting during rotation of the chuck may damage the tool.

- For reverse rotation, set the lever to reverse. Check the direction of rotation before use.

- 2 After use, set the lever to its center position (switch lock)

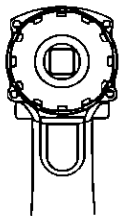

Clutch Torque Setting

Adjust the torque to one of the 18 possible settings or "2" position required to do the job

CAUTION Test the setting before actual operation. Set the scale at this mark (<)

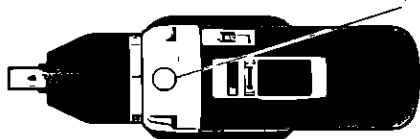

CAUTION To eliminate excessive temperature increase of the tool surface, do not operate the tool continuously, that is consecutively replacing the battery packs

- Do not close up vent holes on the sides of the body during operation. Otherwise, the machine function is adversely affected to cause a failure
- Impact mechanism creates heat. Square drive and accessory become very hot. They may cause burns
- Do not strain the tool (motor). This may cause damage to the unit
- Keep body or skin away from exhaust vent to avoid risk of being burned by hot air
- When operating with a Ni-MH battery pack, make sure the work place is well-ventilated

For Appropriate use of Battery pack

Ni-MH Battery pack EY9230

- Charge the Ni-MH battery fully before storage in order to ensure a longer service life
- The ambient temperature range is between 0°C (32°F) and 40°C (104°F)

If the battery pack is used when the battery temperature is below 0°C (32°F), the tool may fail to function properly. In that case, charge the battery until charging is completed for appropriate functioning of the battery

Battery Pack Life

The rechargeable batteries have a limited life. If operation time becomes extremely short after recharging, replace the battery pack with a new one

Note Use under extremely hot or cold conditions will reduce operating capacity per charge

Charging

Note When you charge the battery pack for the first time, or after prolonged storage, charge it for about 24 hours to bring the batteries up to full capacity

Battery charger (EY0230)

- 1 Plug the charger into the AC outlet
- 2 Insert the battery pack firmly into the charger

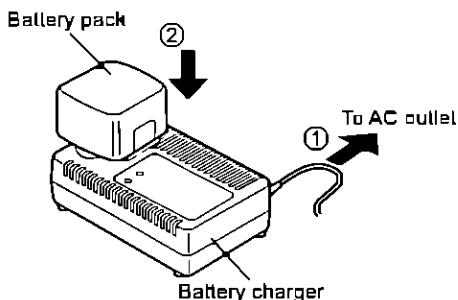

- 3 During charging, the charging lamp will be lit. When charging is completed, an internal electronic switch will automatically be triggered to prevent overcharging
 - Charging will not start if the battery pack is warm (for example, immediately after heavy-duty operation). The orange standby lamp will be lit until the battery cools down. Charging will then begin automatically.
- 4 When charging is completed, the charging lamp will start flashing rapidly

- 5 If the battery pack is too cold, or if the battery pack has not been used for a long time, the charging lamp starts flashing slowly to indicate protective charging. Protective charging takes longer to fully charge the battery pack, than the standard charging time. (Max charging time is approx 90 minutes)
- If a fully charged battery pack is inserted into the charger again, the charging lamp may light up and then flash slowly. After several minutes, the charging lamp may flash quickly to indicate the charging is completed.
- 6 If the charging lamp does not light immediately after the charger is plugged in, or if after the standard charging time the lamp does not go off, consult an authorized servicer.

- Note**
- Before charging a cold battery pack (below 5°C (41°F)) in a warm place, leave the battery pack at the place and wait for more than one hour to warm up the battery to the level of the ambient temperature. (Battery pack may not be fully charged.)
 - Cool down the charger when charging more than two battery packs consecutively.
 - Do not insert your fingers or any metallic objects into charger contact opening.

- CAUTION**
- Do not use power source from an engine generator.
 - Do not cover vent holes on the charger and the battery pack.

LAMP INDICATIONS OF THE EY0230

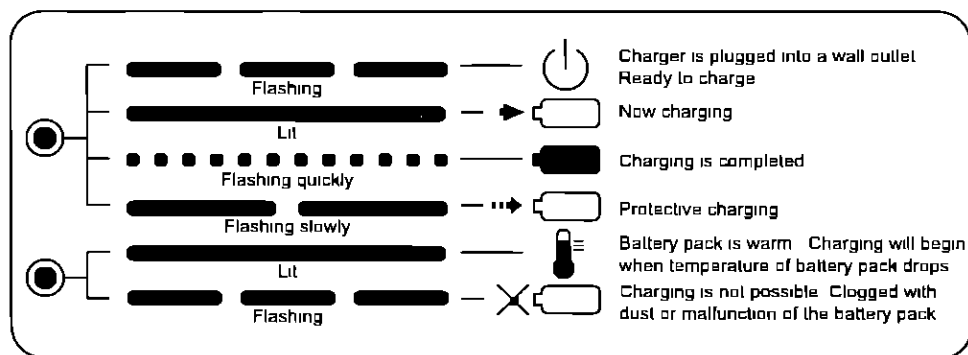

MAINTENANCE

Use only dry, soft cloth for wiping the unit. Do not use a damp cloth, thinner, benzene, or other volatile solvents for cleaning.

BATTERY RECYCLING

ATTENTION

A nickel metal hydride battery that is recyclable powers the product you have purchased. Please call 1-800-8-BATTERY for information on how to recycle this battery.



TIGHTENING TORQUE

- The power required for tightening a bolt will vary, according to bolt material and size, as well as the material being bolted. Choose the length of tightening time accordingly. Reference values are provided below (They may vary according to tightening conditions)

FACTORS AFFECTING TIGHTENING TORQUE

The tightening torque is affected by a wide variety of factors including the followings. After tightening, always check the torque with a torque wrench

1) Voltage

When the battery pack becomes nearly discharged, the voltage decreases and the tightening torque drops

Bolt Tightening Conditions

M6, M8, M10, M12, M14 x 25 mm (1") Standard bolt
 (Bolt size Millimeters)

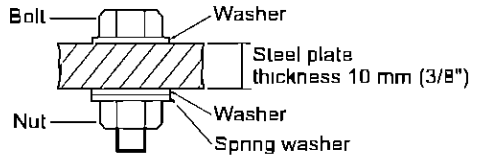
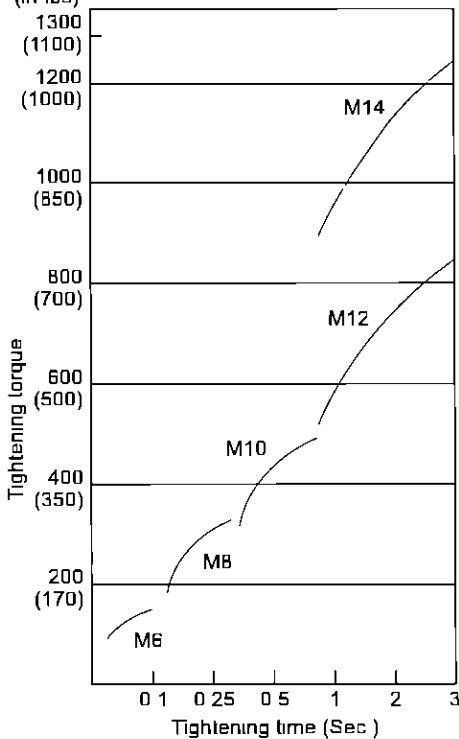

Tightening conditions

- The following bolts are used
 - Standard bolt Strength type 4.8
 - High tensile type 12.9

Explanation of the strength type

- 4.8
 - Bolt yield point (80% of tensile strength) 48 kgf/mm² (68,000psi)
 - Bolt tensile strength 60 kgf/mm² (85,000psi)

- 2) **Tightening time**
Longer tightening time results in increased tightening torque. Excessive tightening, however, adds no value and reduces the life of the tool.
- 3) **Different bolt diameters**
The size of the bolt diameter affects the tightening torque.
Generally, as the bolt diameter increases, tightening torque rises.
- 4) **Tightening conditions**
 - Tightening torque will vary, even with the same bolt, according to grade, length, and torque coefficient (the fixed coefficient indicated by the manufacturer upon production)
 - Tightening torque will vary, even with the same bolting material (e.g. steel), according to the surface finish
 - Torque is greatly reduced when the bolt and nut start turning together
- 5) **Socket play**
 - Torque is lowered as the six-sided configuration of the socket of the wrong size is used to tighten a bolt
- 6) **Switch (Variable speed control trigger)**
Torque is lowered if the unit is used with the switch not fully pulled out.
- 7) **Effect of Connecting Adaptor**
The tightening torque will be lowered through the use of a universal joint or a connecting adaptor.

ACCESSORIES

Use only bits suitable for size of drill's chuck

Use Panasonic original Optional Keyless drill chuck (EY9X003E) and Quick change chuck (EY9HX110E) for maximum performance

SPECIFICATIONS

MAIN UNIT

Model			EY6535		
			Drill driver Mode		Impact mode (Caution. Do not use Keyless drill chuck for impact mode)
Maximum recommended capacities	Drilling	Wood drilling	ø 27 mm (1 - 1/16")		Not feasible
		Metal drilling	ø 13 mm (1/2")		
	Screw driving	Machine screw	M5		Not feasible
		Wood screw	ø 6.8 mm (17/64")		
		Tech screw	ø 6 mm (15/64")		
	Coach screw (Lag bolt)	ø10 mm (3/8")			
Bolt Fastening		Not feasible		Standard Bolt M12 High Tensile Bolt M10	
No load speed			0 - 650 /min (rpm)		0 - 2200 /min (rpm)
Clutch Torque			Approx 1.0 Nm (10 kgf-cm, 8.7 in-lbs) - 5.4 Nm (55 kgf-cm, 47.7 in-lbs)		—
Impact per minute			—		0 - 3300 /min (ipm)
Motor			DC Motor 15.6V		
Square drive			12.7 mm (1/2") square drive with ball detent		
Weight (with battery pack)			2.2 kg (4.8 lbs)		
Overall length			216 mm (8 - 1/2")		

KEYLESS DRILL CHUCK

Model	EY9X003E
Chuck Capacity	1.6 mm - 13 mm (1/16" - 1/2")

BATTERY PACK

Model	EY9230
Storage battery	Ni-MH Battery
Battery voltage	15.6V DC (1.2V x 13 cells)

BATTERY CHARGER

Model	EY0230				
Electrical Rating	See the name plate on the bottom of the charger				
Weight	0.78 kg (1.72 lbs)				
Charging time	15.6 V	12 V	9.6 V	7.2 V	Standard charging time
	—	EY9001 EY9006	EY9080 EY9086	EY9065 EY9066	Approx 20 min
	—	EY9101 EY9103	EY9180 EY9182	—	Approx 25 min
	EY9136	EY9106 EY9107 EY9108	—	EY9168	Approx 30 min
	EY9230	EY9200	—	—	Approx 45 min

Note This chart may include models that are not available in your area

Please refer to the catalogue

CAUTION This Panasonic Multi Drill & Driver is designed to use only battery pack type EY9230, EY9136. Use with other battery pack type may damage the tool and the battery, and may result in the risk of fire and personal injury

**30-DAY QUALITY
SATISFACTION GUARANTEE:**

If you are dissatisfied with any Panasonic Cordless Power Tool for any reason, simply return it to the place of purchase with a dated proof of purchase, in the original packaging, with all accessories, parts and instructions, within 30 days of the date of purchase, for a full refund, or call Panasonic at 201-392-6655. Abuse or misapplication of any power tool voids the guarantee.

PANASONIC CONSUMER ELECTRONICS COMPANY

One Panasonic Way, Secaucus, New Jersey 07094